

JASMINE ROOM
B Level

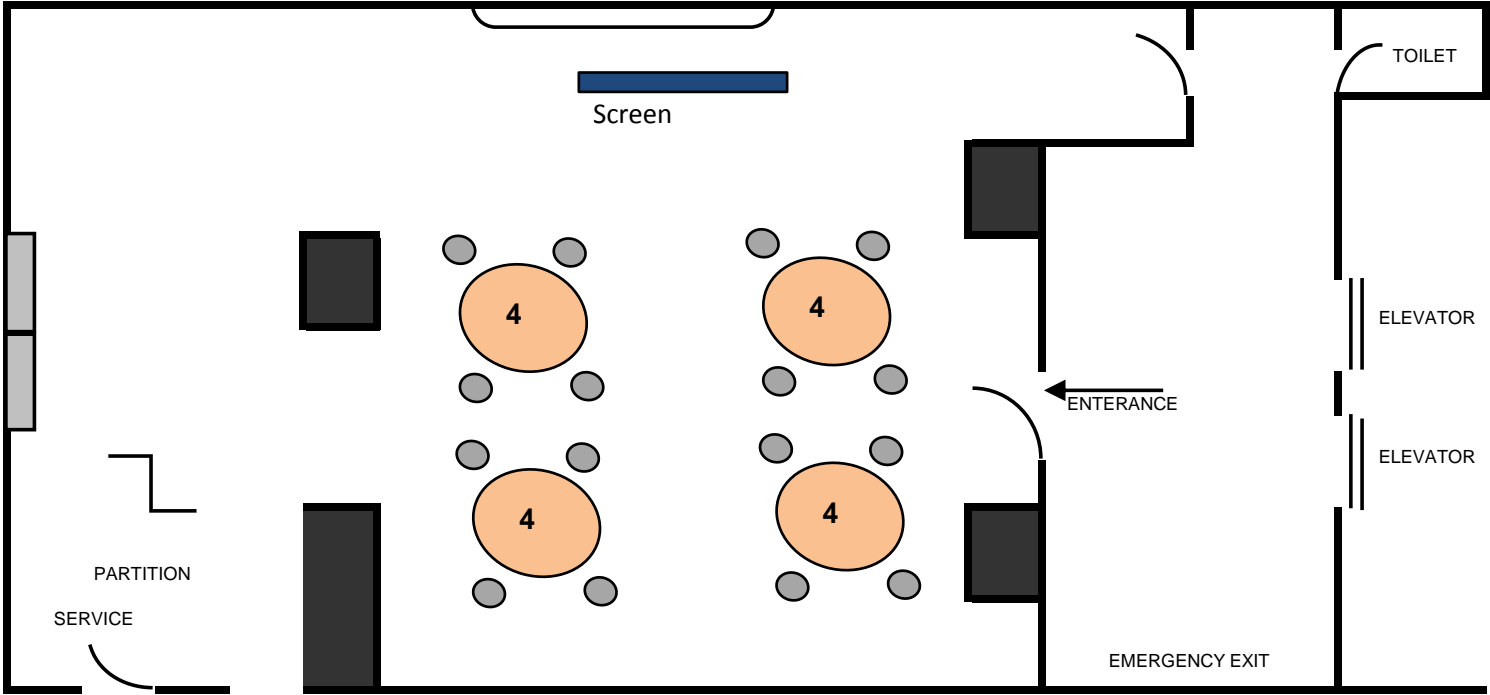

16 PAX - ROUND TABLE SET UP

Room size : 8 x 10 meter
Ceiling size : 2.1 meter

**RAFFLESIA ROOM
Lower Lobby Level**

Upper Level

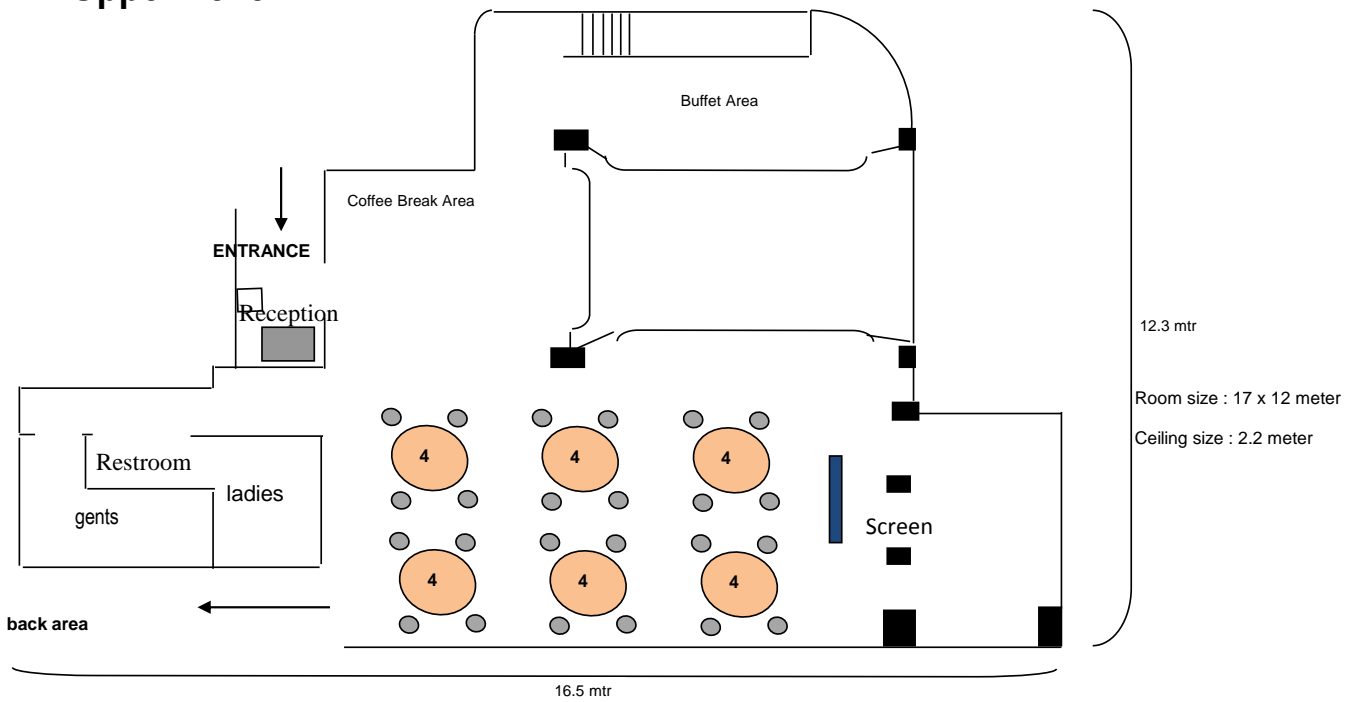

Lower level

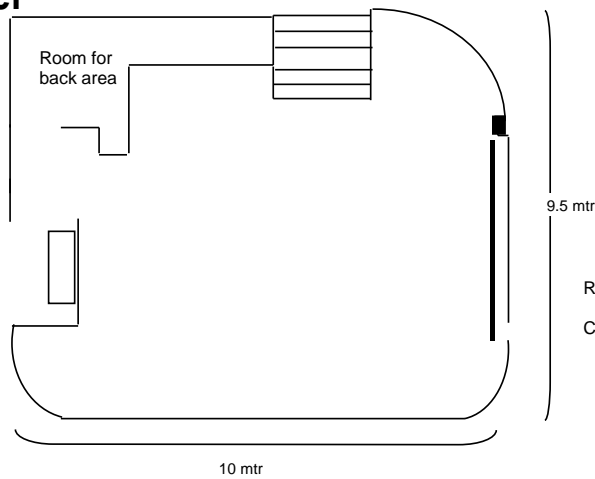

NOTE :
24 PAX ROUND TABLE SET UP ON UPPER LEVEL

Room size : 10 x 9.5 meter
Ceiling size : 2.3 meter

GARDENIA ROOM
Lobby Level

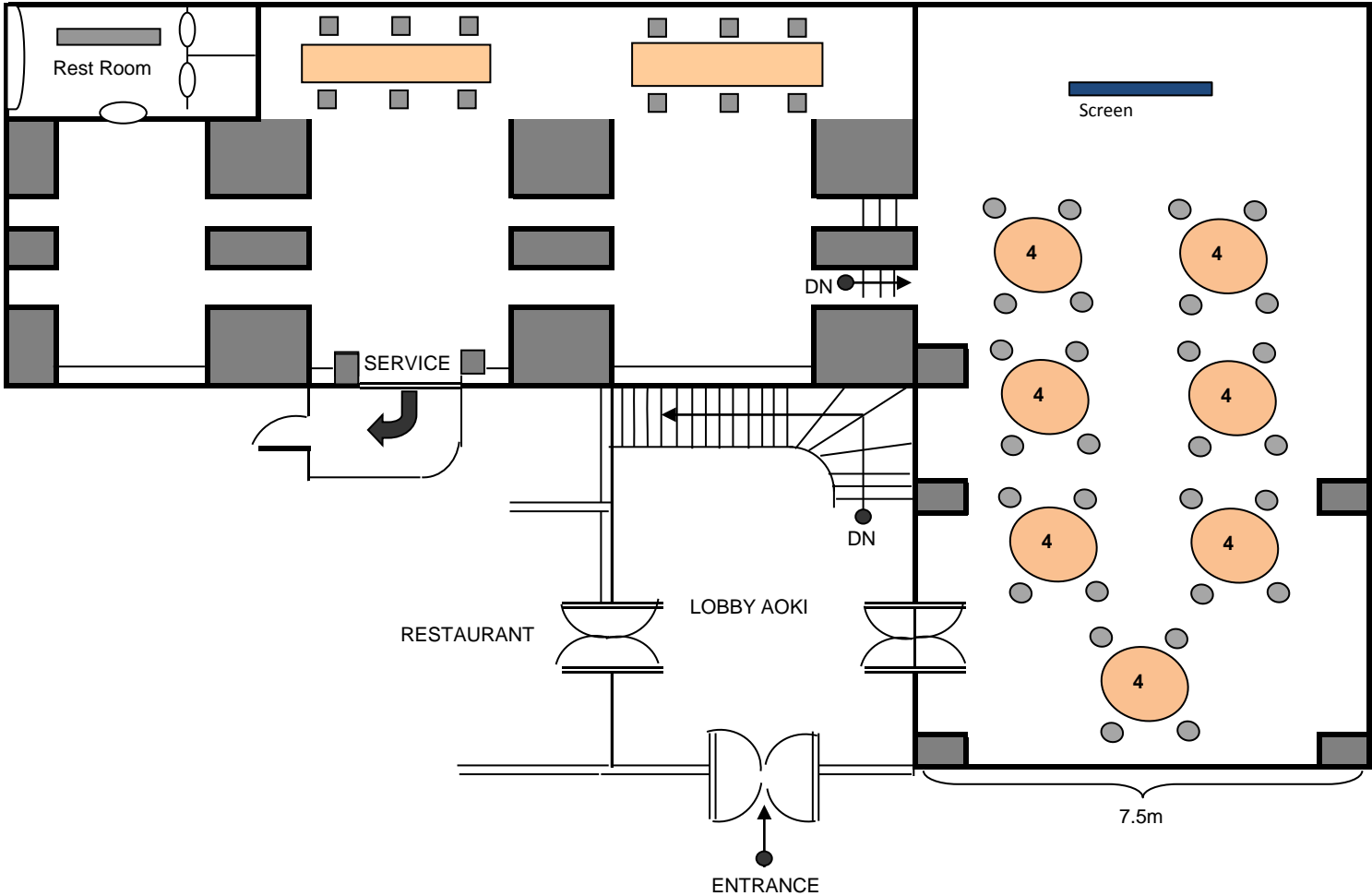

18m

Room size : 18 x 7.5 meter
Ceiling size : 2.9 meter

7.5m

LOWER LEVEL : 28 PAX - ROUND TABLE SET UP

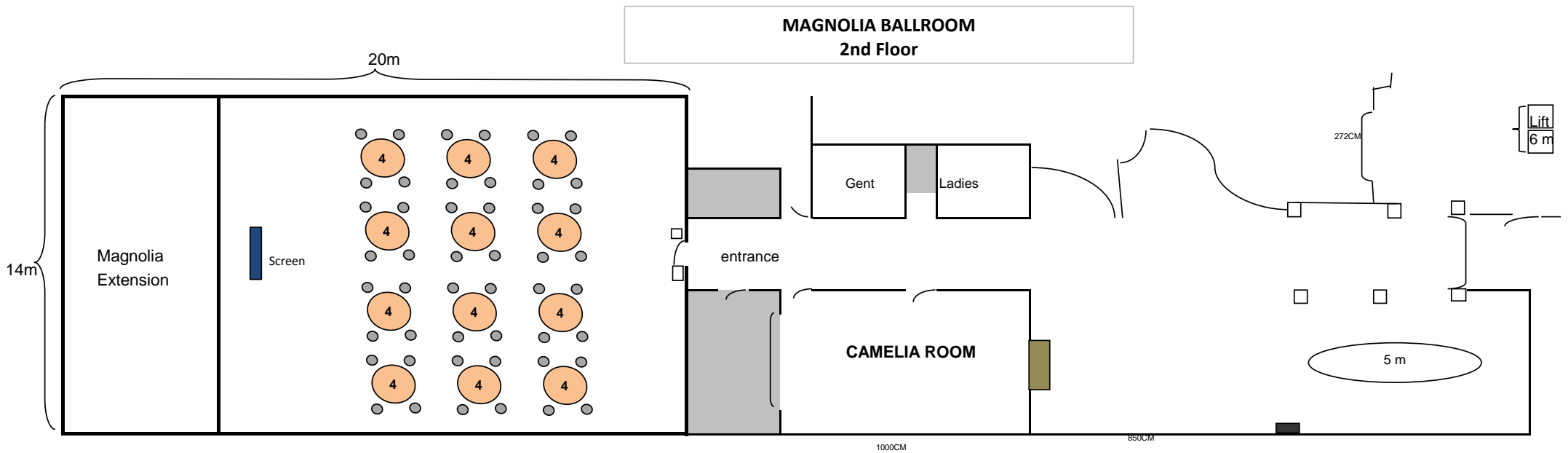

MAGNOLIA BALLROOM
48 PAX in ROUND TABLE SET UP

Room size : 14 x 20 meter
Ceiling size : 3.1 meter

CAMELIA ROOM
2nd Floor

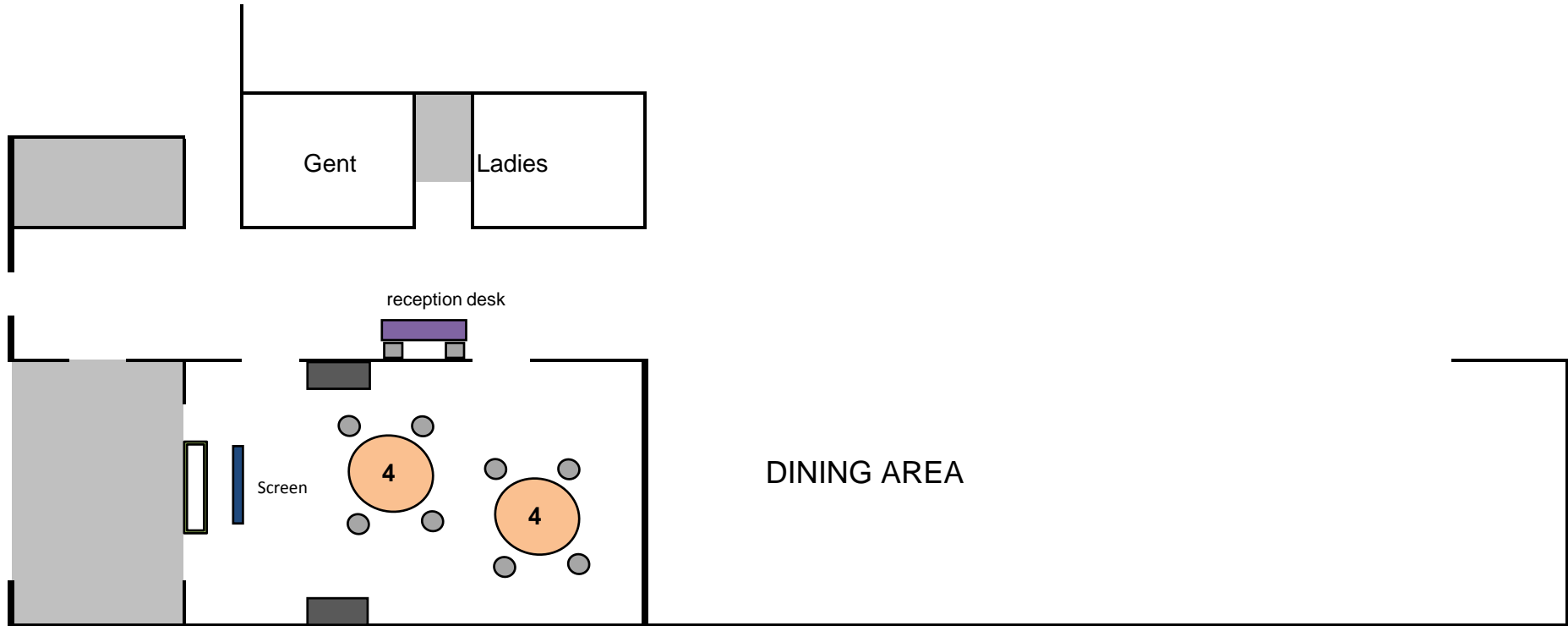

1000CM

Room size : 10 x 6 meter

Ceiling size : 3.1 meter

8 PAX - ROUND TABLE SET UP

CASABLANCA ROOM 6th Level

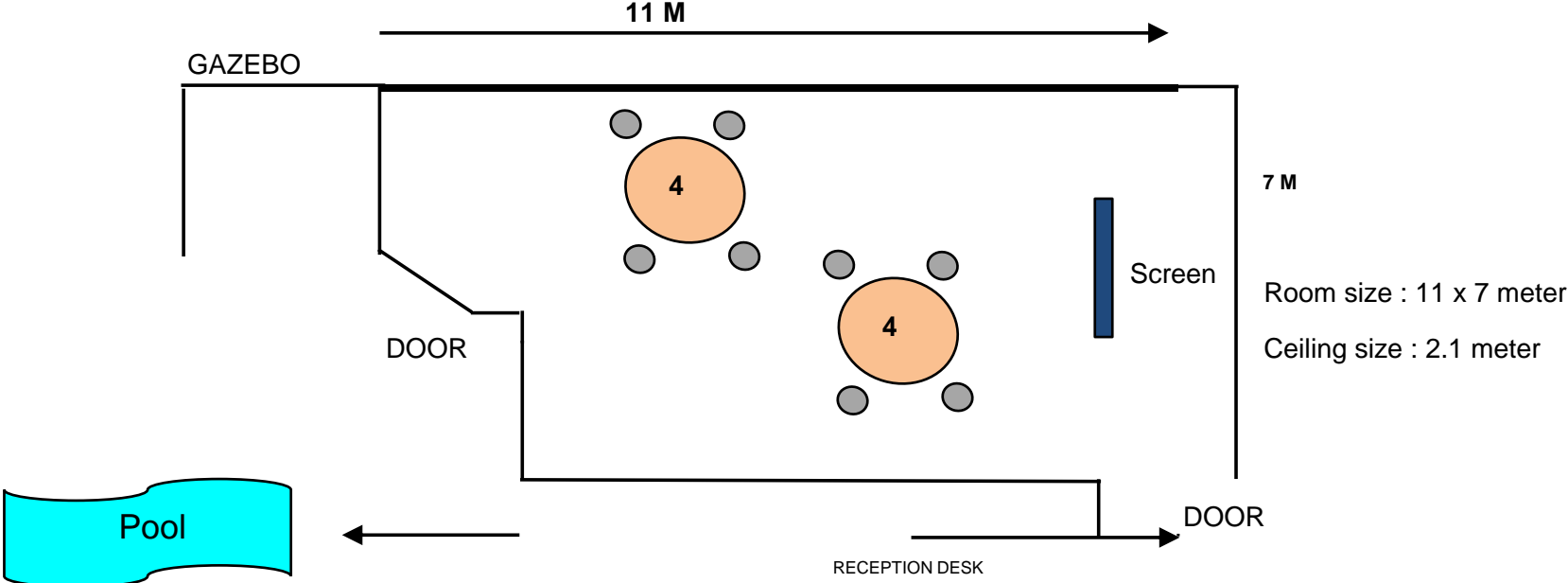

8 PAX - ROUND TABLE SET UP