

CAPACITY & DIMENSIONS

themilneryork.com
01904 653 681
events@themilneryork.com

Meeting Room Capacity

Room	Floor	Theatre	Cabaret	Classroom	Boardroom	U Shape	Dinner	Dinner Dance	Reception	Exhibition Space (sq m)
Events Centre	GF	410	180	180	—	—	250	220	220	285.66
Oak	GF	160	80	80	40	40	120	120	120	161.3
Crown	1F	85	50	35	30	30	50	—	50	84.55
Wedgewood	1F	85	50	35	30	30	50	—	50	84.16
Minster	GF	60	32	24	25	24	40	—	60	83.8
Ebor	GF	60	32	24	20	20	40	—	60	96.3
Leeman	GF	20	—	—	14	—	—	—	—	14.52
Dante	GF	20	—	—	12	—	—	—	—	—
Jorvik	LG	50	32	24	20	20	—	—	—	64.73
Tiles	LG	30	—	20	20	14	—	—	—	—
Clifford	GF	20	—	—	14	8	—	—	—	48

Technical Information

Room	Daylight	Phone Point	Access	3 Phase	AirServer	Wireless or Hardwired	Length (m)	Width (m)	Area (sq m)	Ceiling Height (m)
Events Centre	No	Yes	Direct	Yes	No	Yes	13.8	20.7	285.66	6.1
Oak	Yes	Yes	Direct	Yes	No	Yes	12.8	12.6	161.3	5.18
Crown	Yes	Yes	Lift/ Stairs	No	No	Yes	12.62	6.7	84.55	3.59
Wedgewood	Yes	Yes	Lift/ Stairs	No	No	Yes	12.55	6.7	84.16	3.59
Minster	Yes	Yes	Direct	No	Yes	Yes	11.15	7.52	83.8	5.18
Ebor	Yes	Yes	Direct	No	No	Yes	11.2	8.6	96/3	5.18
Leeman	Yes	Yes	Direct	No	Yes	Yes	4.64	6.94	32.2	3.13
Dante	Yes	Yes	Direct	No	Yes	Yes	3.59	6.33	22.7	3.13
Jorvik	Yes	Yes	Lift/ Stairs	No	Yes	Yes	8.84	7.32	64.73	2.8
Tiles	Yes	Yes	Stairs	No	No	Yes	10.5	5.8	60.9	3.6
Clifford	Yes	Yes	Direct	No	Yes	Yes	10.0	4.8	48.0	3.2

EVENTS CENTRE

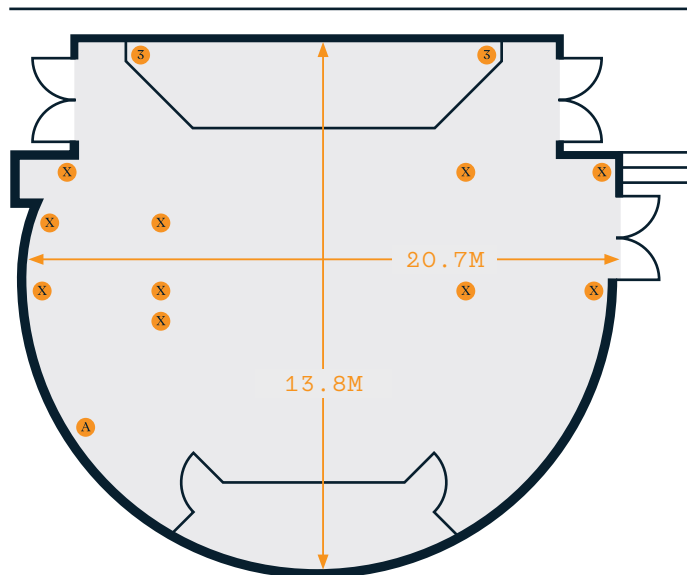

OAK ROOM

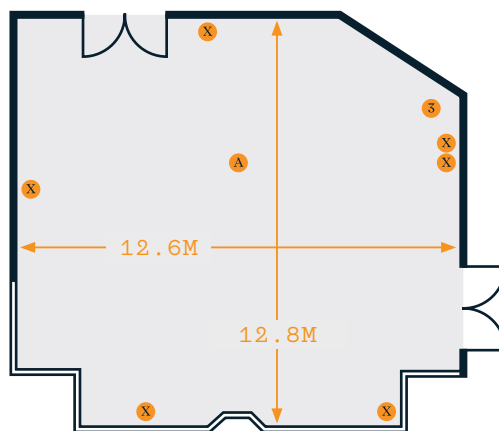

EBOR

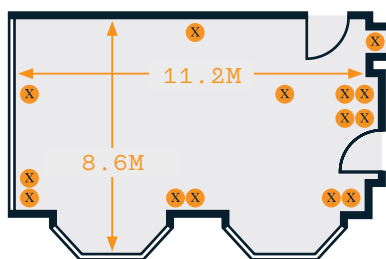

- KEY:
- X DOUBLE POWER POINT
 - S 3 PHASE POWER
 - A AIR CONDITIONING
 - T TELEPHONE POINT

ROOM PLANS

themilneryork.com
01904 653 681
events@themilneryork.com

CROWN

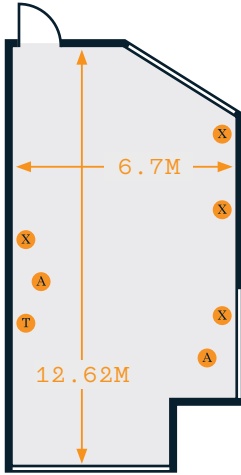

WEDGEWOOD

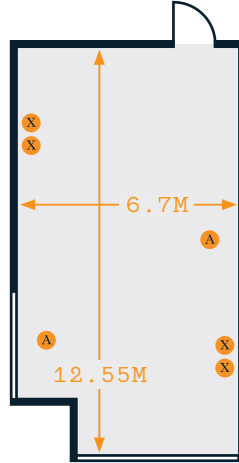

JORVIK

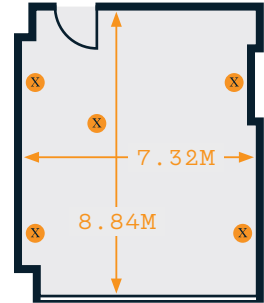

CLIFFORD

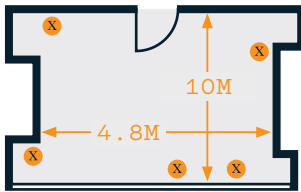

TILES

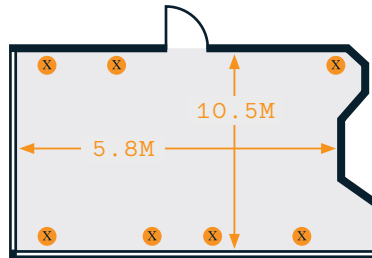

MINSTER

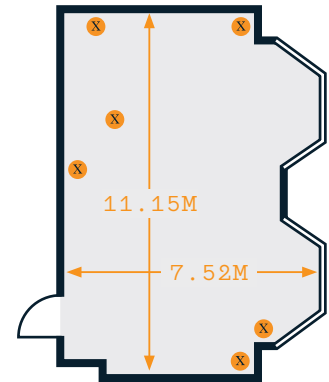

LEEMAN

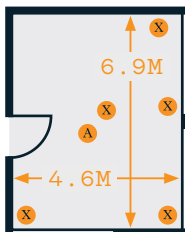

DANTE

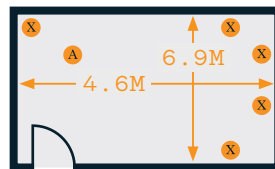

KEY:

- ⊗ DOUBLE POWER POINT
- ⊙ 3 PHASE POWER
- Ⓐ AIR CONDITIONING
- Ⓣ TELEPHONE POINT

THE
MILNER
YORK