

KIDS' MENU BREAKFAST

SILVER DOLLAR PANCAKES 10
maple syrup

CRISPY FRENCH TOAST CUBES 10
cinnamon sugar, maple syrup, whipped cream

TRADITIONAL BREAKFAST 10
one egg, bacon, hashbrown patty, one piece of toast

EGGS BENNY 10
one egg benedict, hashbrown patty

KIDS' FRUIT CUP 5

CANMORE HIKING MALCOLM HOTEL STIRLING SPRING CREEK

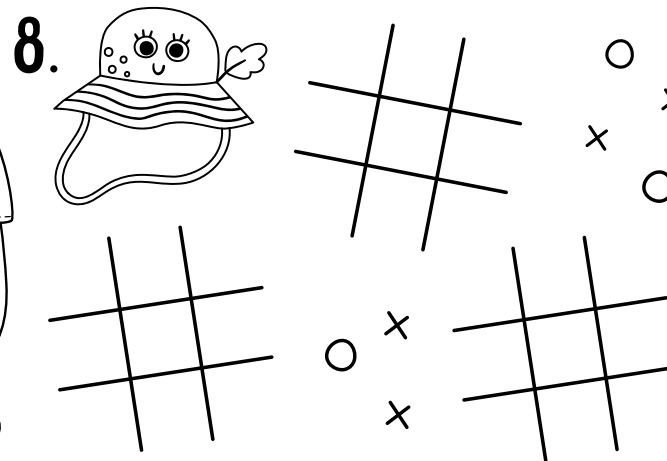
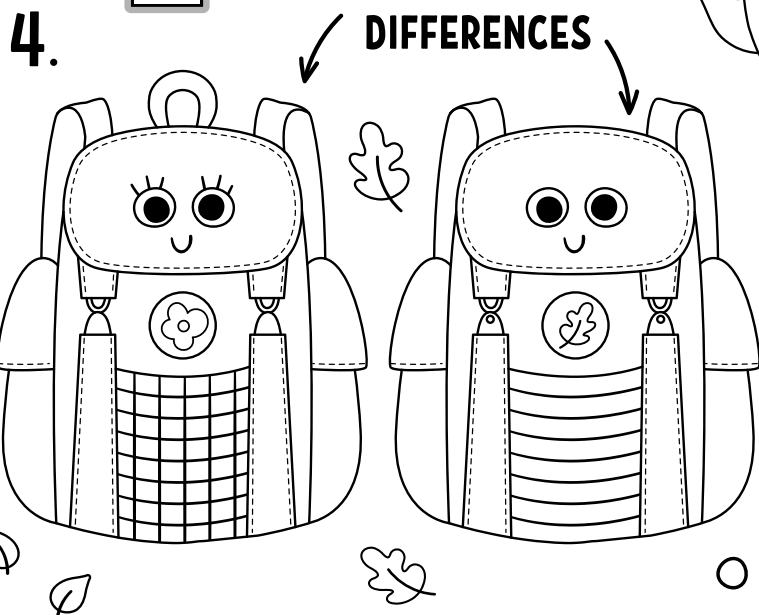
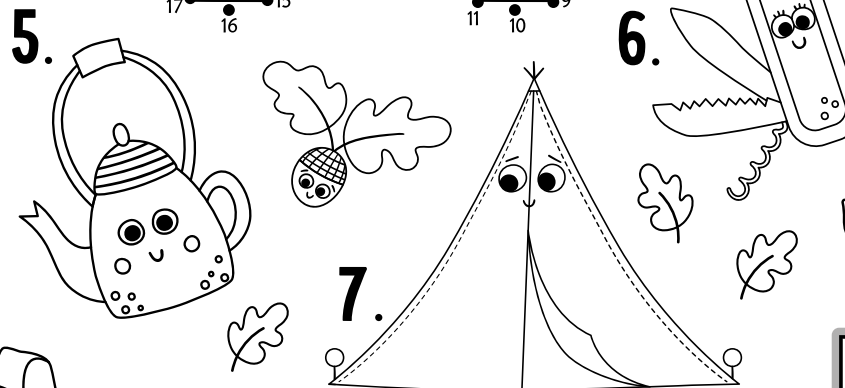
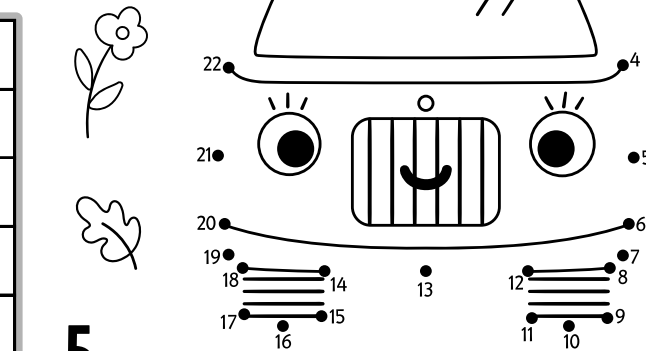
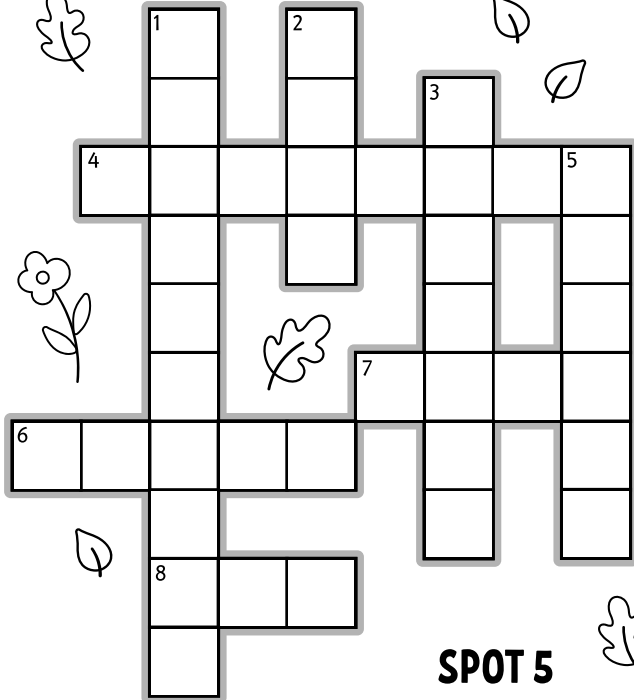
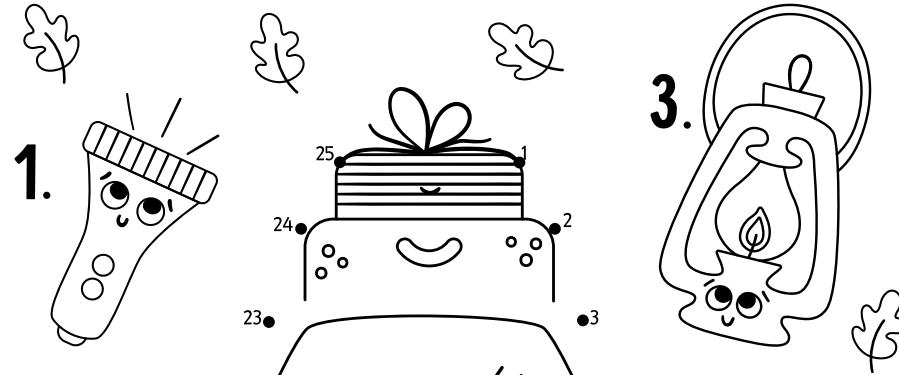
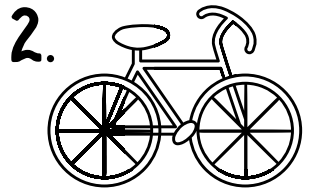

C	A	N	M	O	R	E
H	G	H	A	P	T	O
I	N	R	L	M	C	W
K	I	A	C	K	R	N
I	R	H	O	T	E	L
N	P	U	L	S	E	J
G	S	F	M	B	K	D



THE MALCOLM
HOTEL

